

Panasonic

ideas for life

LC-P1265

For standby power supplies
 Expected trickle life: 6 years at 25°C
 10 years at 20°C



※The product appearance may be different from the standard.

■ Dimensions(mm)

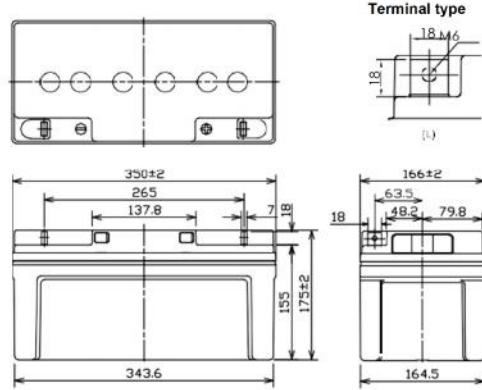

Battery case resin: Flame-retardant (UL94V-0)

■ Specifications

Nominal Voltage		12V
Rated Capacity(20HR)		65Ah
Dimensions	Length	350 mm
	Width	166 mm
	Height	175 mm
	Total height	175 mm
Approx. Mass		19.0 kg
Terminal		M6 threaded post

■ Characteristics

Capacity (25 °C)	20 hour rate	65Ah
	10 hour rate	59Ah
	3 hour rate	48Ah
	1 hour rate	40Ah
Internal Resistance (25 °C)	Fully charged battery	7 mΩ
Temperature Dependency of Capacity (20 hour rate)	40 °C	102%
	25 °C	100%
	0 °C	85%
	-15 °C	65%
Self Discharge (25 °C)	After 3 months	91%
	After 6 months	82%
	After 12 months	64%

■ Duration of discharge vs. discharge current

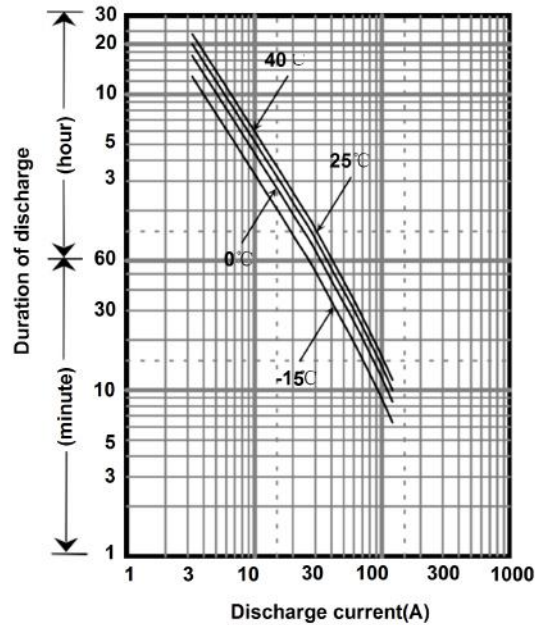

■ Watt Table(25°C)

Cut-off V	(Wattage/Battery)															
	5min	10min	15min	20min	30min	45min	1h	1.5h	2h	3h	4h	5h	6h	10h	20h	
9.6V	1884	1439	1127	956	742	533	501	321	290	201	158	131	115	70.8	39.0	
9.9V	1851	1422	1116	951	734	520	494	313	289	198	157	127	114	70.4	39.0	
10.2V	1735	1386	1093	935	725	515	484	307	281	196	156	126	113	70.1	38.9	
10.5V	1554	1284	1017	888	709	507	474	300	272	193	154	125	112	69.7	38.8	
10.8V	1374	1145	949	865	685	499	465	292	259	189	152	122	111	69.0	38.6	

■ Ampere Table(25°C)

Cut-off V	(Ampere/Battery)															
	5min	10min	15min	20min	30min	45min	1h	1.5h	2h	3h	4h	5h	6h	10h	20h	
9.6V	195	129	98.0	82.4	63.4	45.4	42.2	27.2	24.5	16.9	13.2	11.1	9.60	6.05	3.27	
9.9V	193	127	97.0	82.0	62.7	44.3	41.6	26.5	24.4	16.6	13.1	10.8	9.56	6.02	3.27	
10.2V	183	124	95.0	80.6	62.0	43.9	40.8	26.0	23.8	16.4	13.0	10.7	9.52	5.99	3.26	
10.5V	166	115	88.4	76.6	60.6	43.2	40.0	25.4	22.9	16.3	12.9	10.6	9.41	5.96	3.25	
10.8V	150	102	82.5	74.5	58.5	42.5	39.2	24.7	21.9	15.8	12.8	10.3	9.26	5.90	3.23	

All mentioned values are average values

■ **Charging Method** (25°C)

Trickle use	Control voltage:13.6-13.8V Initial current:9.75A or smaller
-------------	--

■ **Cut off voltage**

Discharge current	3.25A-13.0A	13.0A-32.5A	32.5A-65.0A	65.0A-130A	130A-195A
Cut off voltage(V)	10.5	10.2	9.9	9.3	8.7

■ **Influence of Temperature on Trickle life**

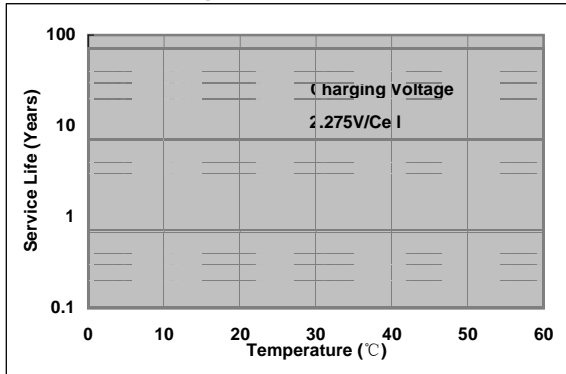

■ **Residual capacity test result**

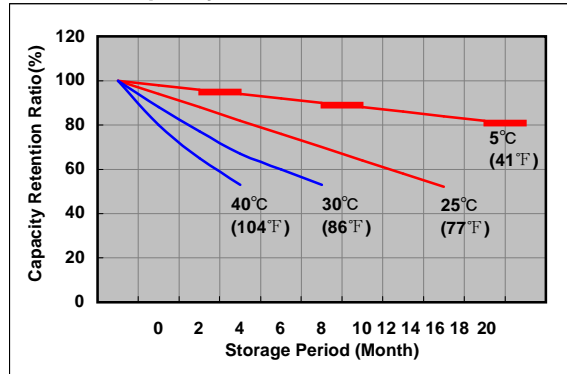

■ **Constant-voltage constant-current charge characteristics for Trickle use**

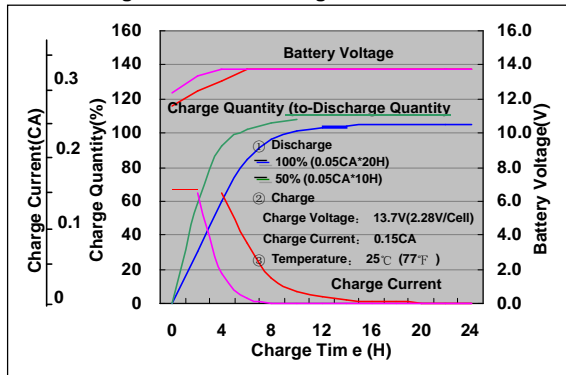

■ **Discharge capacity by temperature and by discharge current**

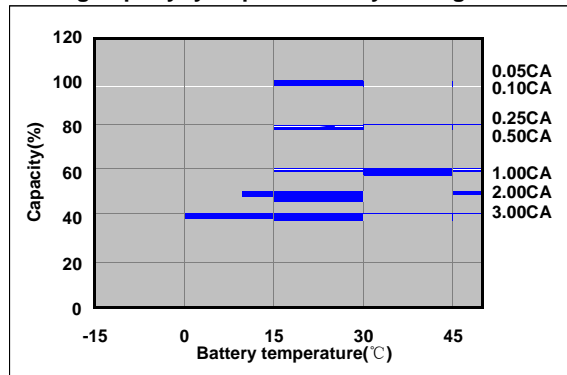

■ **Discharge characteristics(25°C)**

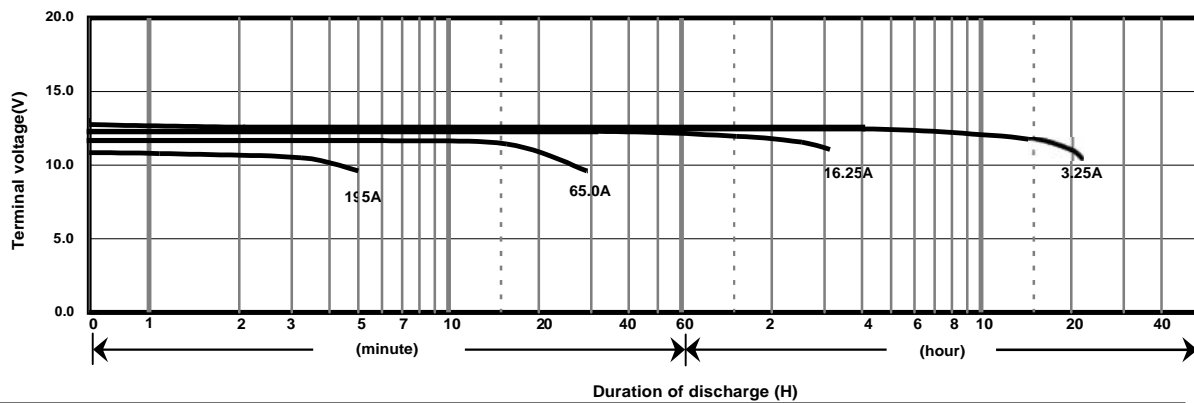

COSTA POWER INDUSTRIES PVT. LTD.

209, 2nd Floor, Infinity Business Park, Behind Pendharkar College,
MIDC Phase - 1, Dombivli(E), Thane - 421023.
Phone No. - 9820710392 / 9372217661.
Email - sales@upsbatteriesindia.com / sunil@upsbatteriesindia.com.